



MONTAGEANLEITUNG

GARTENHAUS MALLORCA



GARTENHAUS MALLORCA

- Holzart: Nordisches Fichtenholz unbehandelt
- Wandstärke: 44 mm
- Außenmaß: 600x500 cm
- Vordach: +235,5 cm
- Firsthöhe: ca. 293 cm
- Grundfläche: 27,8 m²
- Umbauter Raum: 69,6 m³
- Türen: 1 Doppeltür mit Ausschnitt für Echtglas
- Fenster: 2 Doppelfenster aus Echtglas zum Öffnen



ALLGEMEINE HINWEISE

Lese vor Beginn des Aufbaus die komplette Montageanleitung, um eventuelle Unklarheiten vorab mit unserem Fachpersonal zu besprechen. Wir helfen dir - So muss das!



Telefon
05931 - 496 576 0



E-Mail
info@steda-online.de

Änderungen vorbehalten.



MONTAGEANLEITUNG

GARTENHAUS MALLORCA

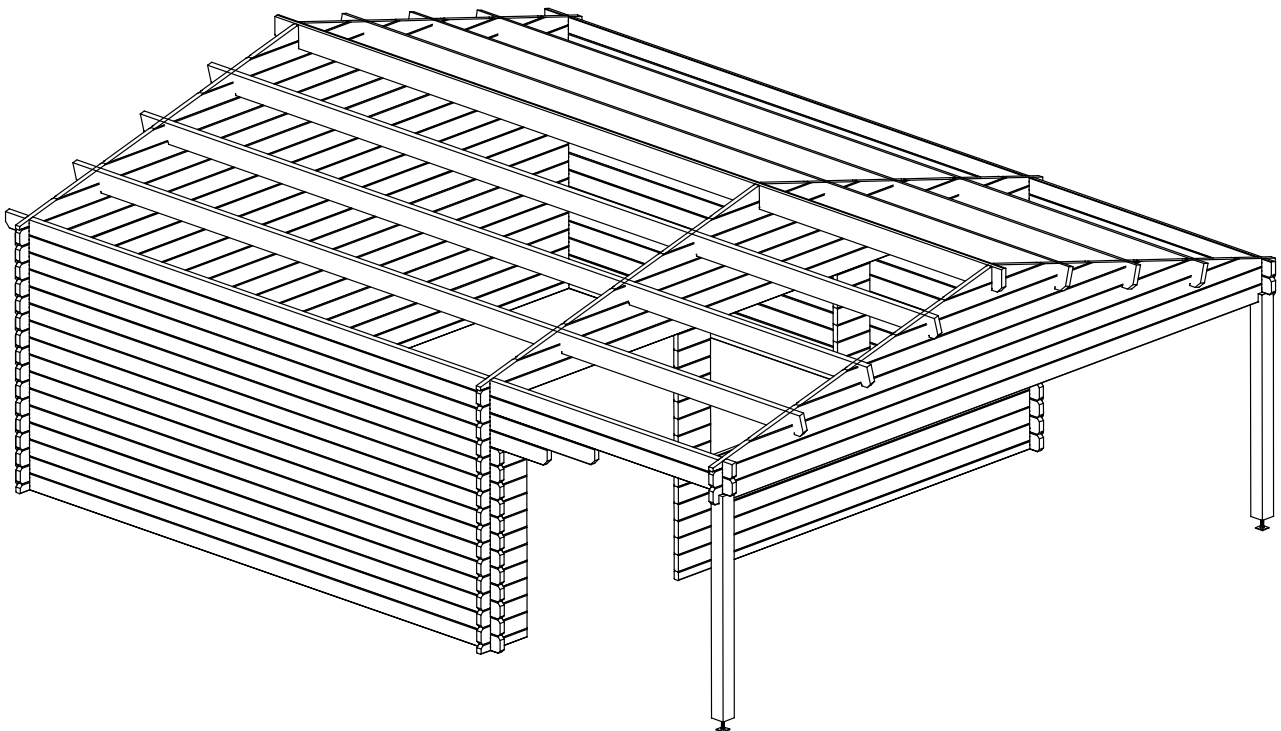
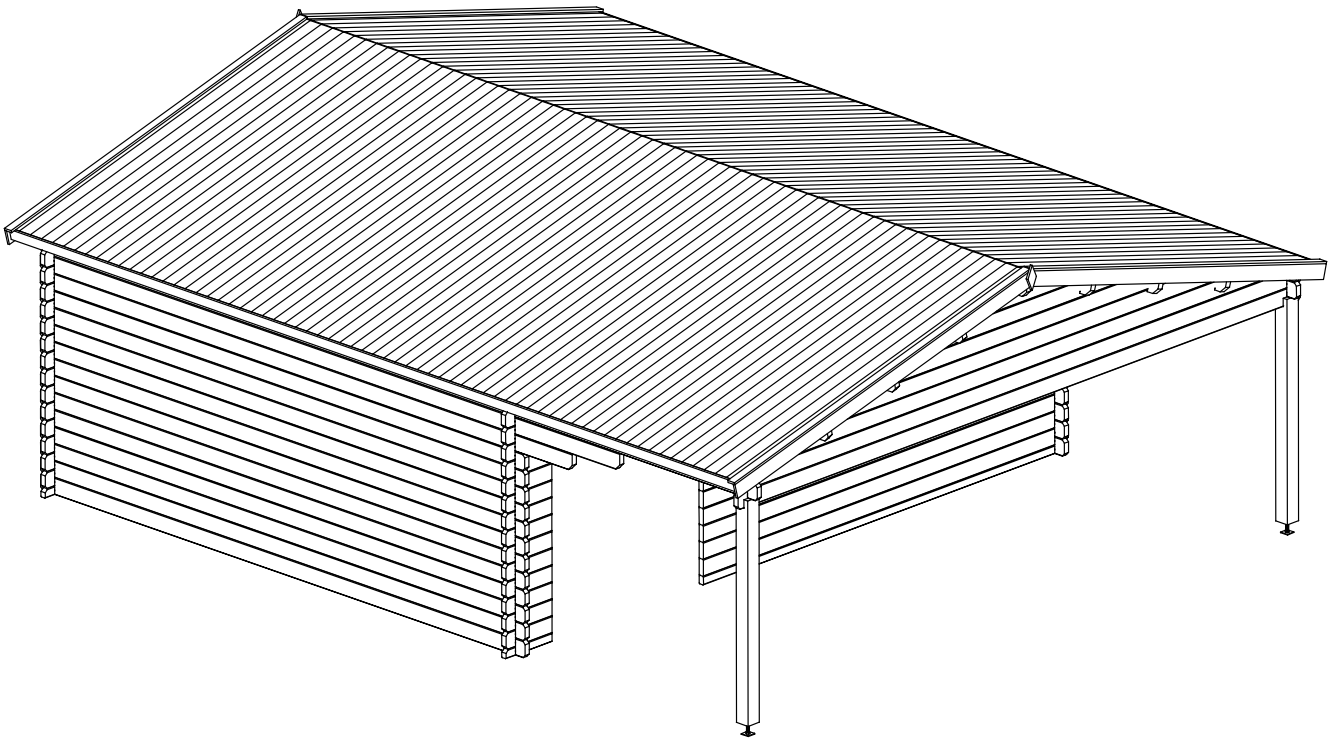

Änderungen vorbehalten.



MONTAGEANLEITUNG

GARTENHAUS MALLORCA



GRUNDPLAN

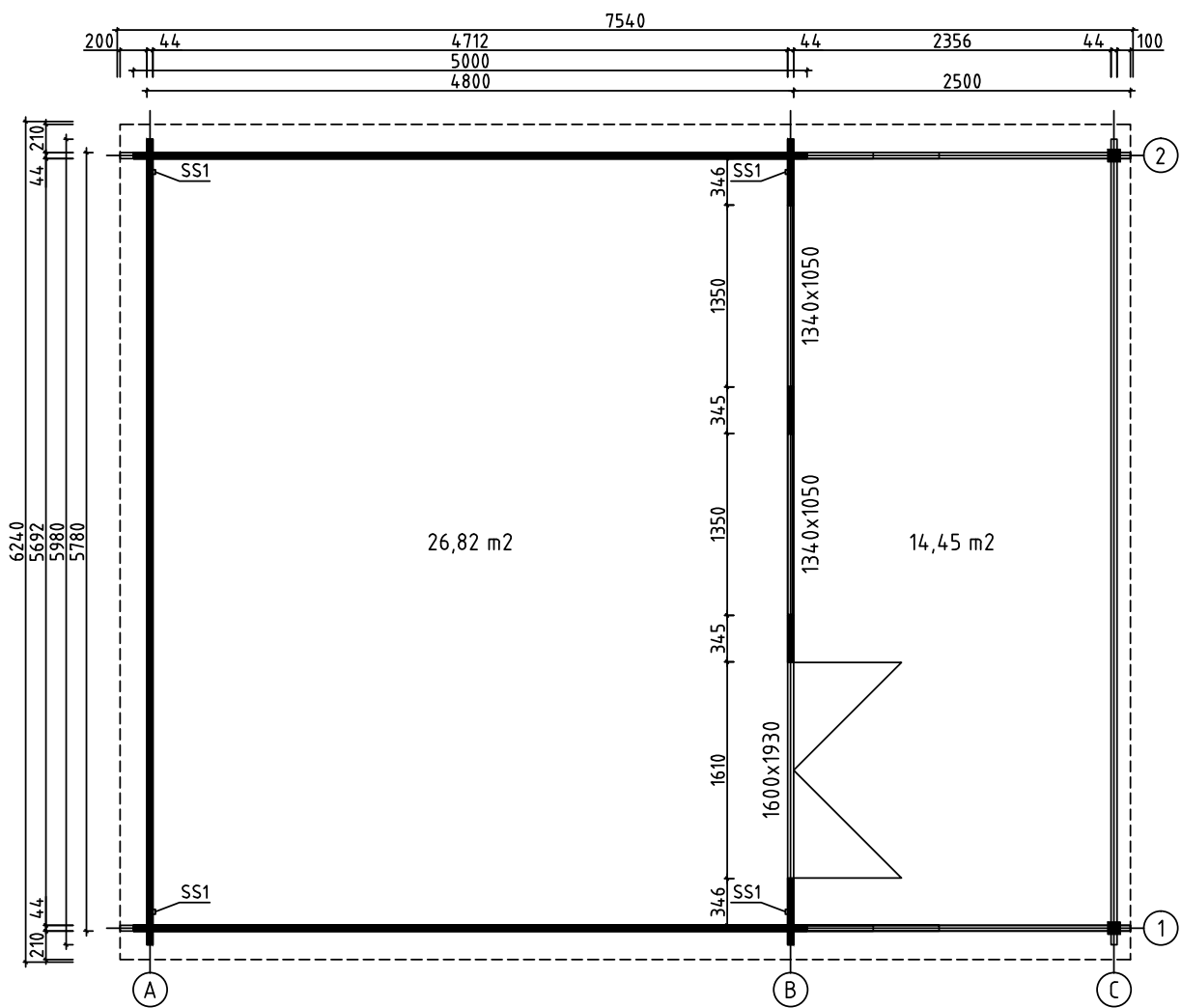

Änderungen vorbehalten.



MONTAGEANLEITUNG

GARTENHAUS MALLORCA



DACHBALKEN

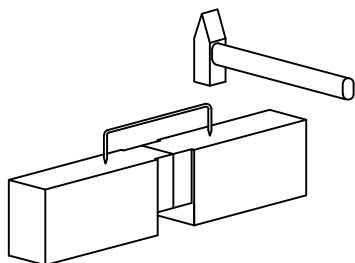
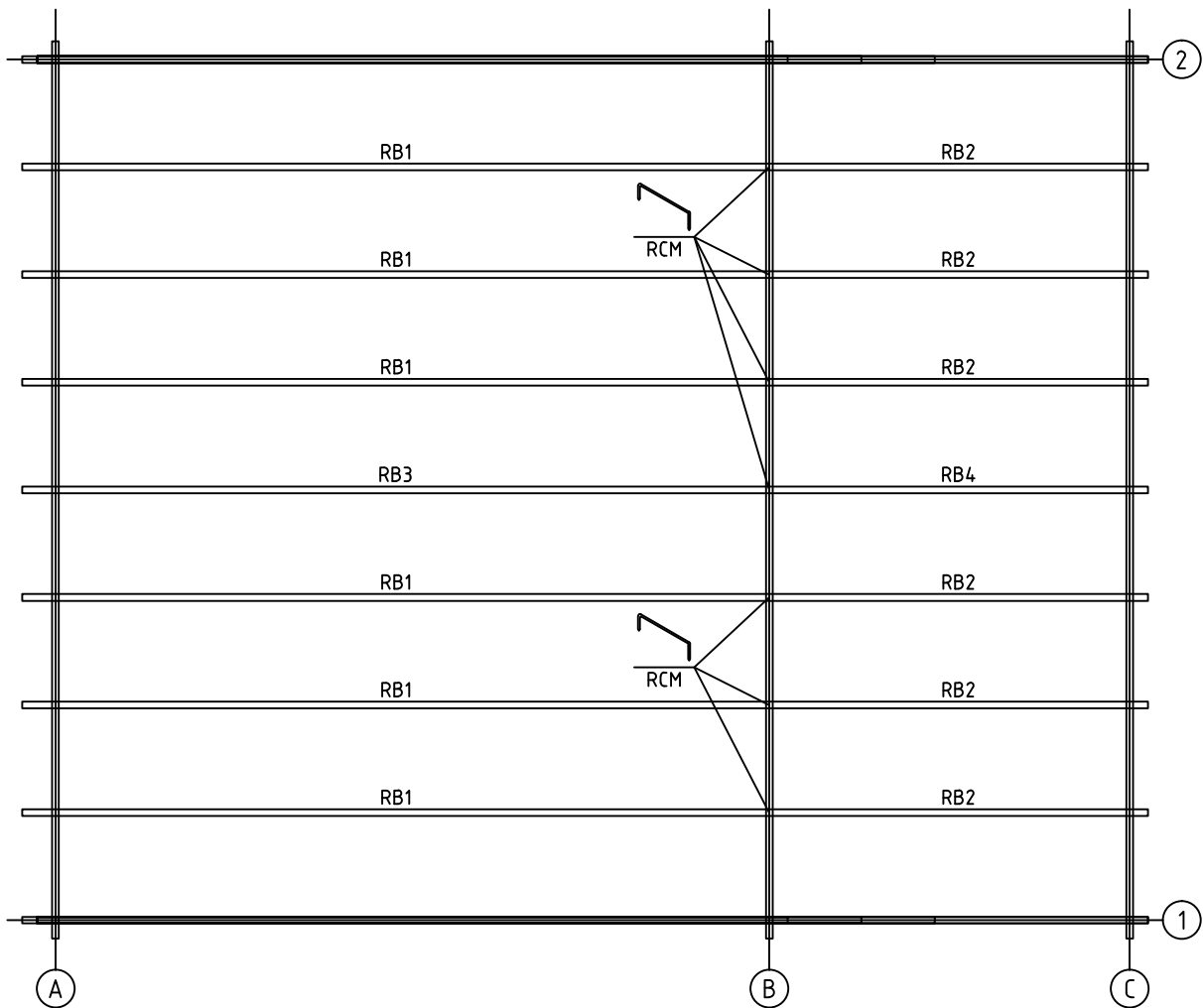

Änderungen vorbehalten.



MONTAGEANLEITUNG

GARTENHAUS MALLORCA



RÜCKWAND

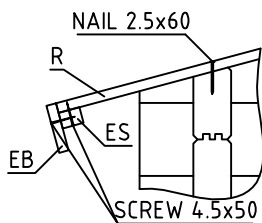
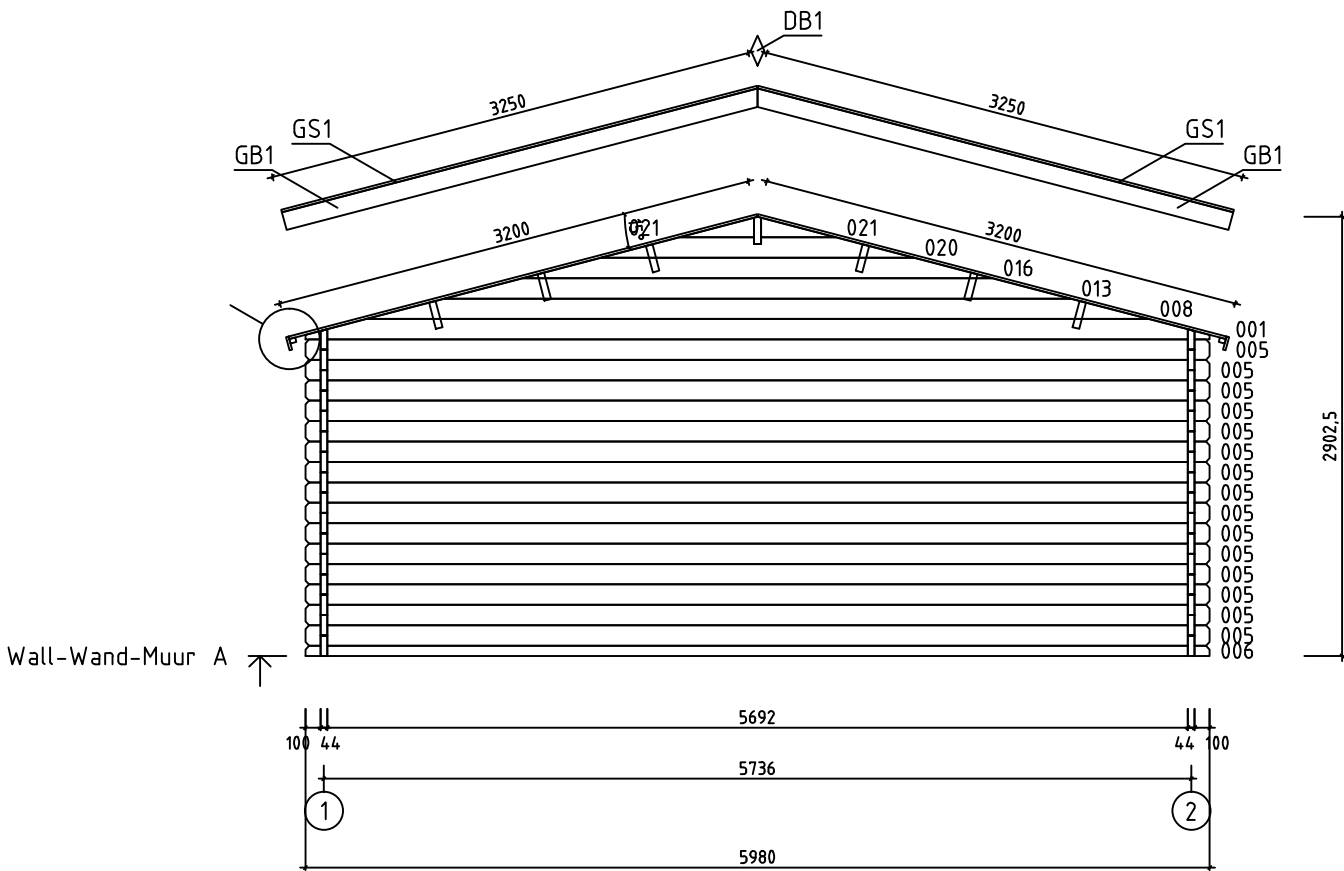

Änderungen vorbehalten.



MONTAGEANLEITUNG

GARTENHAUS MALLORCA



VORDERSEITE

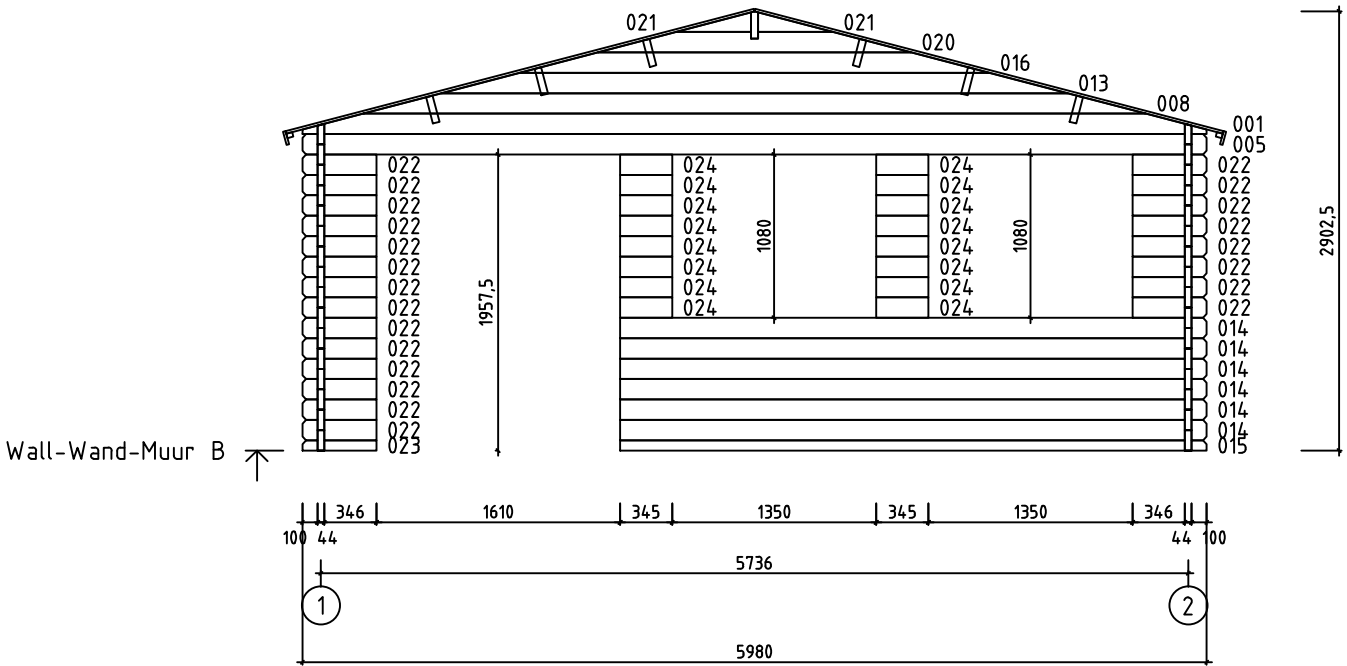

VORDACH

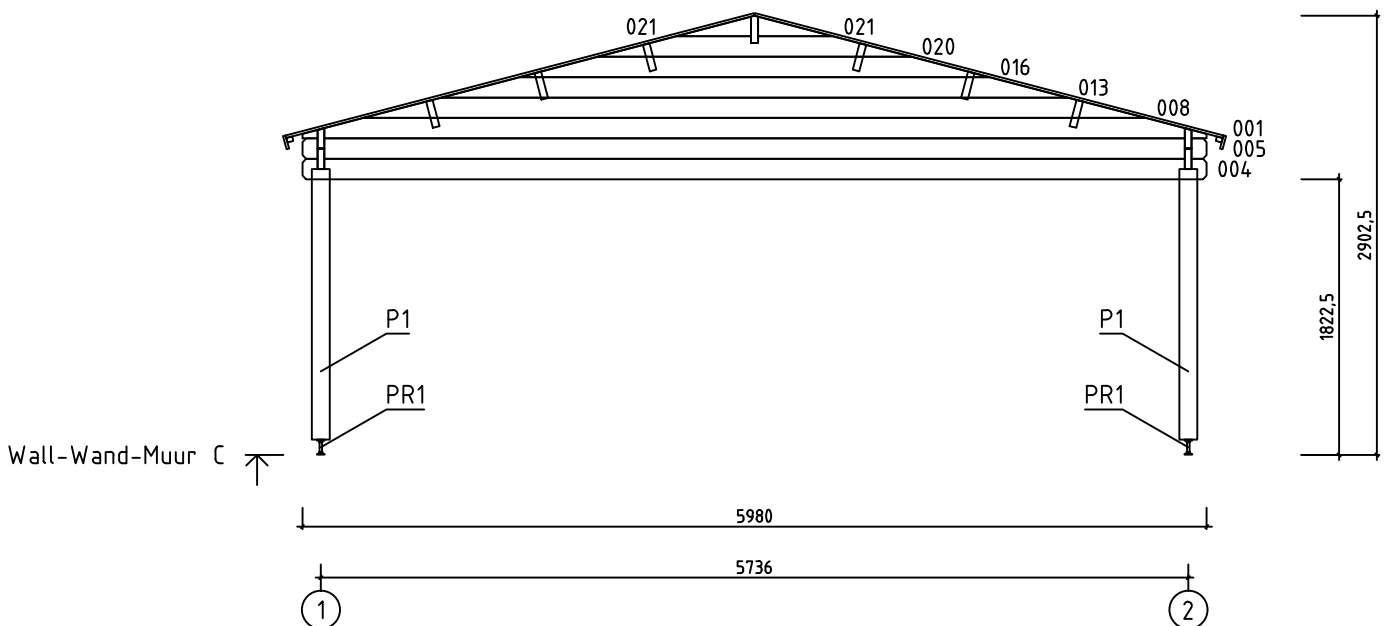

Änderungen vorbehalten.



MONTAGEANLEITUNG

GARTENHAUS MALLORCA



SEITENANSICHT RECHTS

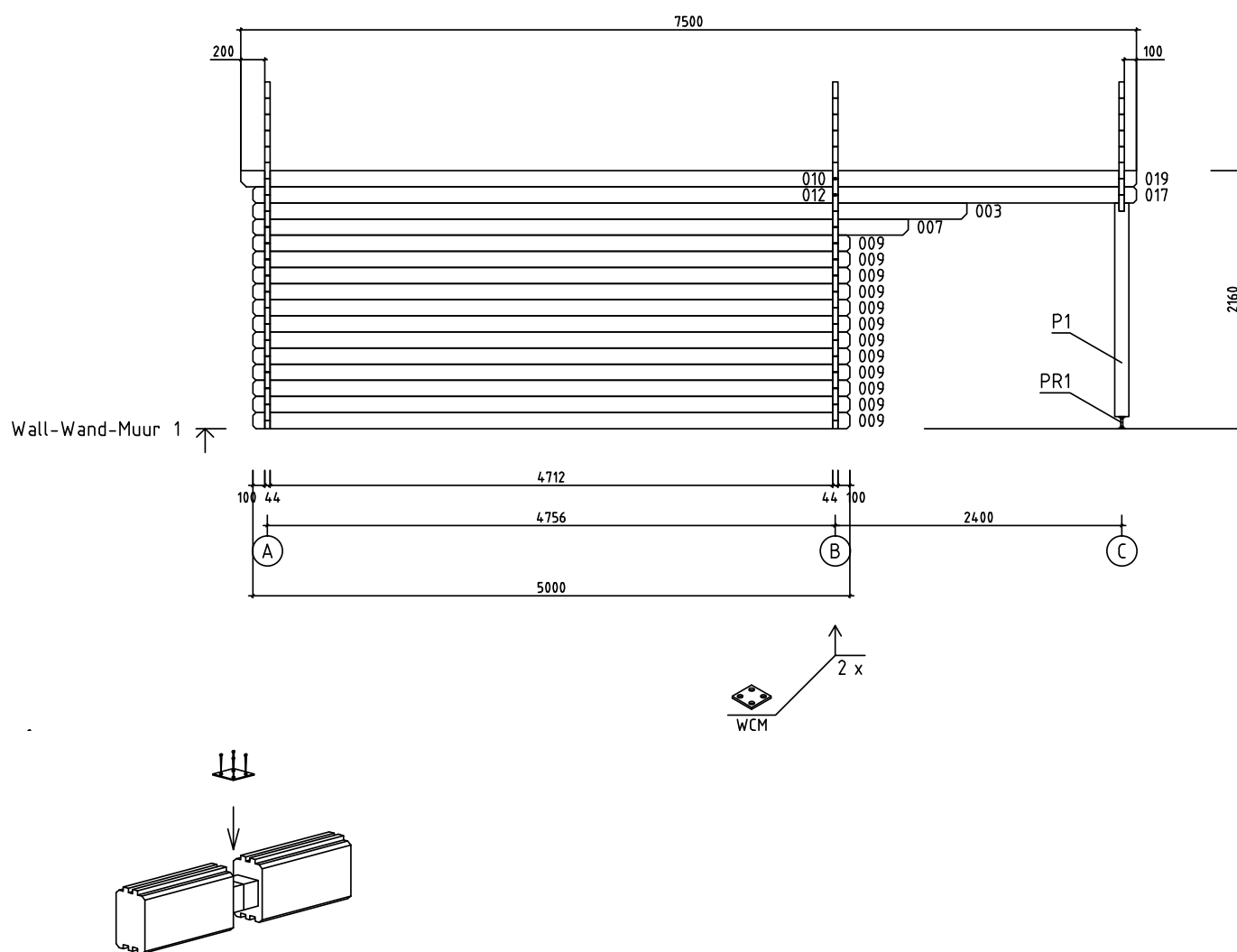

Änderungen vorbehalten.



MONTAGEANLEITUNG

GARTENHAUS MALLORCA



SEITENANSICHT LINKS

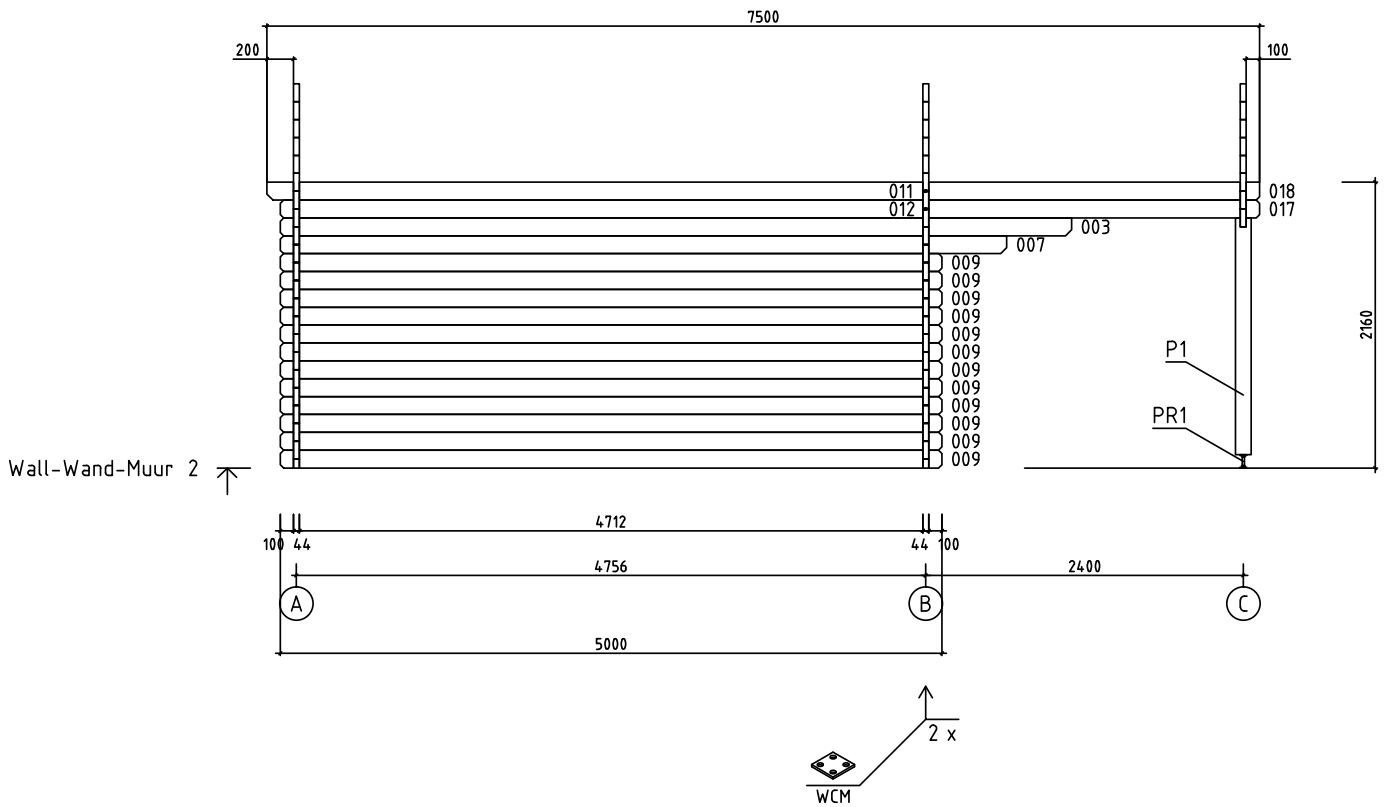

Änderungen vorbehalten.



MONTAGEANLEITUNG

GARTENHAUS MALLORCA



STÜCKLISTE

Pos	Specification-Bestimmung-Omschrijving	Pcs	Profile (mm)	L (mm)
002	SPARE BEAM-ERZATZBOHLE-VOORRAADPLANK 100 5692 100	1	44x135	5980
003	100 4712 1080	2	44x135	5980
004	100 5692 100	1	44x135	5980
005	100 5692 100	17	44x135	5980
006	100 5692 100	1	44x68	5980
007	100 4712 590	2	44x135	5490
009	100 4712 100	24	44x135	5000
010	200 4712	1	44x135	4978
011	200 4712	1	44x135	4978
012	100 4712	2	44x135	4878
014	3736 100	6	44x135	3880
015	3736 100	1	44x68	3880
017	2356 100	2	44x135	2522
018	2356 100	1	44x135	2522
019	2356 100	1	44x135	2522
022	346 100	22	44x135	490





Änderungen vorbehalten.



MONTAGEANLEITUNG

GARTENHAUS MALLORCA

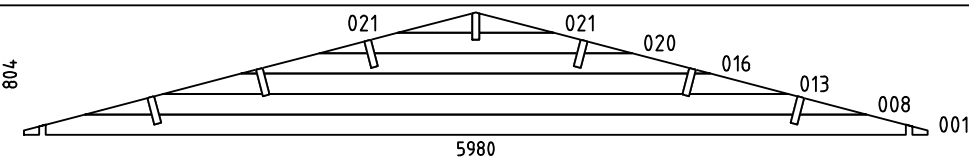

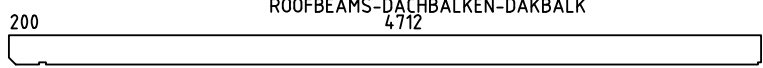
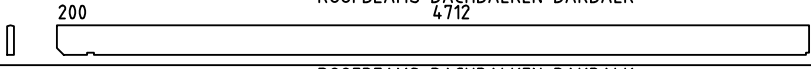
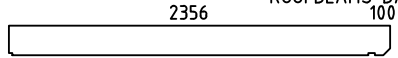
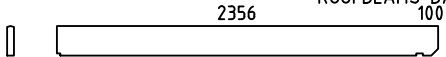









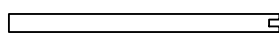

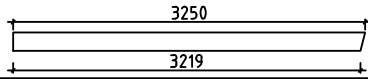



Pos	Specification-Bestimmung-Omschrijving	Pcs	Profile (mm)	L (mm)
023	 100 346	1	44x68	490
024		16	44x135	345
WA-1 WB-1 WC-1		3	44x804	5980
HB	HIT BLOCK-SCHLAGHÖLZER-BLAZENPLANK 	2	44x135	300
RB1	 ROOFBEAMS-DACHBALKEN-DAKBALK 4712	6	45x195	4978
RB3	 ROOFBEAMS-DACHBALKEN-DAKBALK 4712	1	45x195	4978
RB2	 ROOFBEAMS-DACHBALKEN-DAKBALK 100	6	45x195	2522
RB4	 ROOFBEAMS-DACHBALKEN-DAKBALK 100	1	45x195	2522

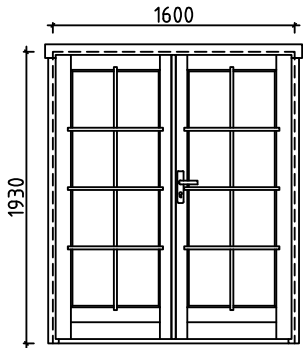
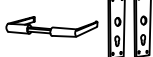

MONTAGEANLEITUNG

GARTENHAUS MALLORCA



Pos	Specification-Bestimmung-Omschrijving	Pcs	Profile (mm)	L (mm)
P1	POST-PFOSTEN-STUT  	2	120x120	1790
R1	ROOFBOARD-DACHBRETT-DAKPLANK  or-oder-of	132+2 172+2	18x114 18x88	3200
GB1	GABLE BOARD-GIEBELBLENDE-GEVELPLANK 	4	18x120	3250
GS1	ROOF FELT FILLET-GIEBELLEISTE-GEVELLIJST 	4	18x70	3250
EB1	EAVE BOARD-TRAUFBRETT-AFDEKPLANK 	6	18x90	2500
ES1	EAVE SLAT-TRUFENLEISTE-AFDEKLIJST 	6	30x40	2500
DB1	DIAMOND-RAUTE-DIAMANT 	2	18x90	200
SS1	STORM SLAT-STURMLEISTE-STORMLIJST 	4	18x35	2060
PR1	POST REGULATOR-PFOSTEN REGLER-STUT REGELAAR 	2		
RCM	ROOFBEAMS CONNECTING METAL-DACHBALKEN BEFESTIGUNGSMETALLE-DAKBALKEN POOLING METALEN 	7	∅6.0	200
WCM	WALLBEAMS CONNECTING METAL-WANDBOHLN BEFESTIGUNG METALLE-MUURBALKEN POOLING METALEN 	4	25	25
	SCREWS-SCHRAUBEN-SCHROEF FOR-FÜR-VOOR SS1 	12	∅6.0	50
	WASHER-SCHEIBE-SCHIJF FOR-FÜR-VOOR SS1 	12	∅6.0	18
	DOUBLEDOOR-DOPPELTÜR-DUBBELE DEUR (right-rechts-rechts) AST_ISO_PL P      	1 1 1 6 2	1600	1930

Änderungen vorbehalten.



MONTAGEANLEITUNG

GARTENHAUS MALLORCA



Pos	Specification-Bestimmung-Omschrijving	Pcs	Profile (mm)	L (mm)
	DOUBLE WINDOW-DOPPEL FENSTER-DUBBELE VENSTER (right-rechts-rechts) AST_ISO_KP	P	2	1340
	 	2		
		4		



MONTAGEANLEITUNG

GARTENHAUS MALLORCA



HK-Lasur

Dekorative, lösemittelbasierte
Premium-Holzschutz-Lasur
für Holz im Freien



weiß*



farblos*



hemlock*



pinie/lärche



kiefer



eiche hell



eiche rustikal



mahagoni



teak



nussbaum



kastanie



palisander



ebenholz



salzgrün



tannengrün



Sonderfarbe

* Diese Farben nur für nicht direkt bewitterte Außenflächen wie Dachuntersichten usw. oder als Grundierung verwenden.

Biozide sicher verwenden. Vor Gebrauch stets Kennzeichnung und Produktinformationen lesen.

Holzschutzcreme

Lasur für den Schutz
und die Veredelung von
Holz im Außenbereich



eiche hell



pinie/lärche



kiefer



mahagoni



teak



nussbaum



palisander



weiß



silbergrau

Holzschutz- und Isoliergrund / UV-Schutz Lasur





MONTAGEANLEITUNG

GARTENHAUS MALLORCA



Deckfarbe

Wasserbasierte, hochdeckende
Wetterschutzfarbe für Holz im
Außenbereich

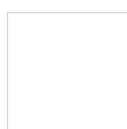

weiß*



hellgrau*



dunkelgrau



königsblau



friesenblau



moosgrün



flaschengrün



nussbraun



tabakbraun



rotbraun



schwed. rot



maisgelb



goldgelb



schwarz



hellelfenbein*



skand. rot



anthr. grau



Sonderfarbe

* Bei diesen Farben ist zusätzlicher
Isoliergrund nötig. Bei dunklen
Deckfarben kann es aufgrund starker
Sonnenanziehung zur Trocknung des
Holzes und damit verbunden, zur
Rissbildung kommen.